

### ABSOLUTE MAXIMUM RATINGS

Item	Symbol	Min.	Max.	Unit
Supply Voltage(L logic)	V <sub>DD</sub> - V <sub>SS</sub>	-0.3	3.7	V
Supply Voltage(LCD)	V <sub>OUT</sub> - V <sub>SS</sub>	-0.3	15.0	V
Input Voltage	V <sub>I</sub>	-0.3	V <sub>DD</sub> + 0.3	V
Operating Temp.	T <sub>opr</sub>	-20	70	°C
Storage Temp.	T <sub>stg</sub>	-30	80	°C

### MECHANICAL DATA

Item	Nominal Dimensions	Unit
Module Size ( W x H x T )	67.4 x 34.9 x 5.0	mm
Viewing Area ( W x H )	59.0 x 26.0	mm
Dot Pitch ( W x H )	0.41 x 0.34	mm
Dot Size ( W x H )	0.37 x 0.30	mm
Weight	Approx. 18	g

### ELECTRICAL CHARACTERISTICS ( V<sub>DD</sub>=2.7V to 3.3V )

Item	Symbol	Test Condition	Min.	Typ.	Max.	Unit
Input High Voltage	V <sub>IH</sub>	--	0.8V <sub>DD</sub>	--	V <sub>DD</sub>	V
Input Low Voltage	V <sub>IL</sub>	--	0	--	0.2V <sub>DD</sub>	V
Output High Voltage	V <sub>OH</sub>	I <sub>OH</sub> = -0.5mA	0.8V <sub>DD</sub>	--	V <sub>DD</sub>	V
Output Low Voltage	V <sub>OL</sub>	I <sub>OL</sub> = 0.5mA	0	--	0.2V <sub>DD</sub>	V
Supply Current	I <sub>DD</sub>	V <sub>DD</sub> = 3.0V	--	0.5	1.0	mA
LCD Driving Voltage	V <sub>0</sub> - V <sub>SS</sub>	T <sub>a</sub> =25°C	--	9.0	--	V

### PIN CONNECTIONS

Pin	Symbol	Level	Function
1	IRS	H/L	H: Use internal resistors for booster L: Use external resistors for booster
2	P/S	H/L	H: Parallel mode L: Serial mode
3	C86	H/L	H: 6800 MPU L: 8080 MPU
4	VR	--	V0 voltage adjustment terminal
5-9	V0-V4	--	Power supply for LCD drive
10	CAP2-	--	Capacitor 2 negative connection
11	CAP2+	--	Capacitor 2 positive connection
12	CAP1+	--	Capacitor 1 positive connection
13	CAP1-	--	Capacitor 1 negative connection
14	CAP3+	--	Capacitor 3 positive connection
15	V <sub>OUT</sub>	--	DC/DC voltage converter output
16	V <sub>SS</sub>	0V	GND
17	V <sub>DD</sub>	2.4-3.3V	Power supply for logic and booster
18-25	D7-D0	H/L	Data bus line
26	/RD	L	Read signal. Active "L"
27	/WR	L	Write signal. Active "L"
28	A0	H/L	H: Display data L: Instruction code
29	/RES	L	Reset signal. Active "L".
30	/CS1	L	Chip selection signal. Active "L".

### BLOCK DIAGRAM

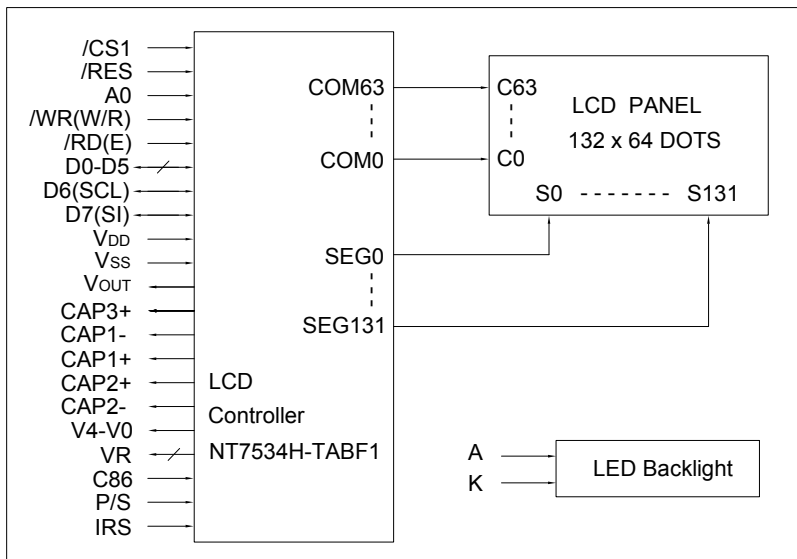

### LED BACKLIGHT SPECIFICATIONS (T<sub>a</sub>=25°C)

Item	Symbol	Typ.	Max.	Unit
Forward Voltage	V <sub>f</sub>	3.0	3.2	V
Forward Current	I <sub>f</sub>	30	--	mA
LED Color		White		