

LG1281281-DW 128 x 128 dots + white led backlight

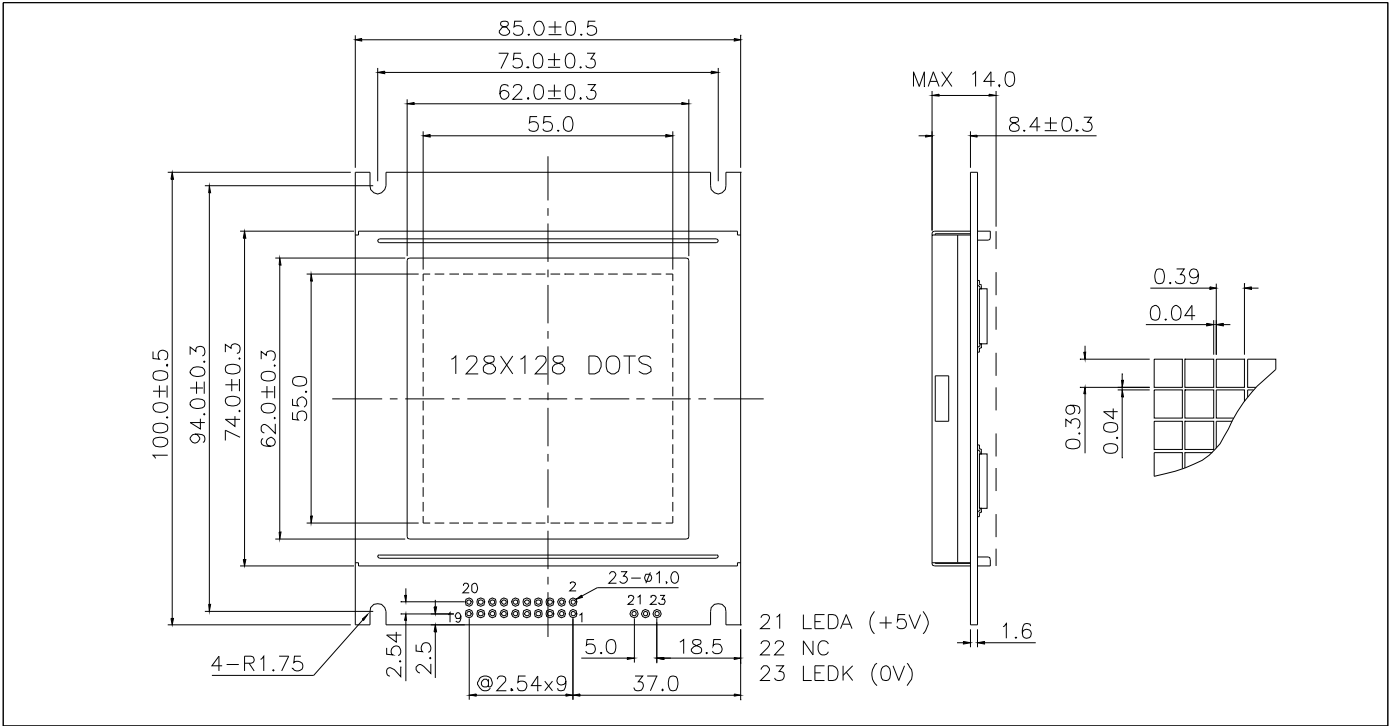

ABSOLUTE MAXIMUM RATINGS

Item	Symbol	Min.	Max.	Unit
Supply Voltage(Logic)	V _{DD} - V _{SS}	-0.3	7.0	V
Supply Voltage(LCD)	V _{DD} - V _O	-0.3	25.0	V
Input Voltage	V _I	-0.3	V _{DD} + 0.3	V
Operating Temp.	T _{opr}	-20	70	°C
Storage Temp.	T _{stg}	-30	80	°C

MECHANICAL DATA

Item	Nominal Dimensions	Unit
Module Size (W x H x T)	85.0 x 100.0 x 14.0	mm
Viewing Area (W x H)	62.0 x 62.0	mm
Dot Pitch (W x H)	0.43 x 0.43	mm
Dot Size (W x H)	0.39 x 0.39	mm
Weight	Approx. 120	g

ELECTRICAL CHARACTERISTICS (V_{DD}=5V±0.25V)

Item	Symbol	Test Condition	Min.	Typ.	Max.	Unit
Input High Voltage	V _{IH}	--	V _{DD} -2.2	--	V _{DD}	V
Input Low Voltage	V _{IL}	--	- 0.3	--	0.8	V
Output High Voltage	V _{OH}	--	V _{DD} -0.3	--	V _{DD}	V
Output Low Voltage	V _{OL}	--	0	--	0.3	V
Supply Current	I _{DD}	V _{DD} = 5.0V	--	15.0	20.0	mA
LCD Driving Voltage	V _{DD} - V _O	T _a =25°C	--	18.2	--	V

PIN CONNECTIONS

Pin	Symbol	Level	Function
1	FG	--	Frame ground
2	V _{SS}	0V	GND
3	V _{DD}	+5V	Power supply for logic
4	V _O	--	Operating voltage for LCD
5	/WR	L	Write signal, active "L"
6	/RD	L	Read signal, active "L"
7	/CE	L	Chip enable signal, active "L"
8	C/D	H/L	L : Data H : Instruction code
9	NC	--	No connection
10	/RST	L	Reset signal, active "L"
11	DB0	H/L	Data bus line
12	DB1	H/L	
13	DB2	H/L	
14	DB3	H/L	
15	DB4	H/L	
16	DB5	H/L	
17	DB6	H/L	
18	DB7	H/L	
19	FS	H/L	Font selection L: 8x8, H: 6x8
20	V _{OUT}	-15V	Output voltage for LCD driving

BLOCK DIAGRAM

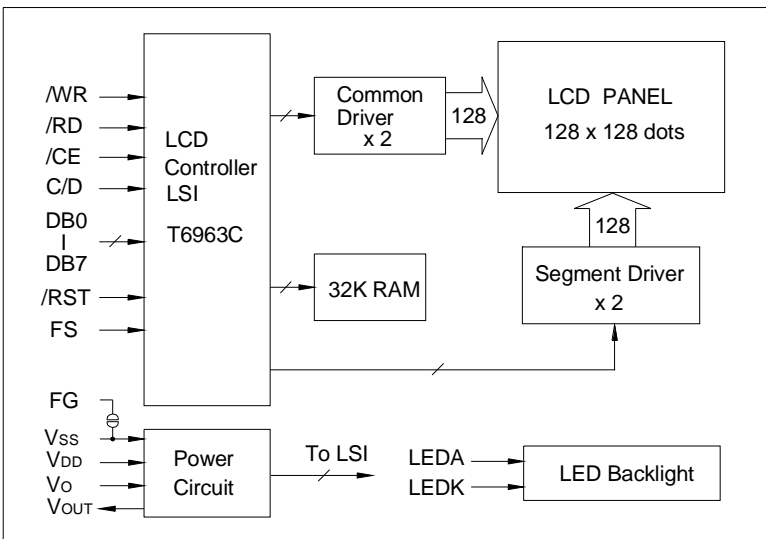

LED BACKLIGHT SPECIFICATIONS (T_a=25°C)

Item	Symbol	Typ.	Max.	Unit
Forward Voltage	V _f	3.1	3.3	V
Forward Current	I _f	105	--	mA
LED Color		White		